

Leveraging Advanced Technologies in Industrial Composting Plants: Exploring Technical and Logistical Opportunities to Achieve Industry 4.0 Standards

Einsatz innovativer Technologien in industriellen Kompostieranlagen: Erkundung technischer und logistischer Optimierungsmöglichkeiten zur Erreichung von Standards der Industrie 4.0

Max Cichocki¹
Christian Landschützer¹

¹Institute of Logistics Engineering,
Graz University of Technology, Austria

This research explores technical and logistical opportunities to achieve Industry 4.0 standards at industrial composting plants through a model-based systems engineering (MBSE) approach. As traditional composting methods rely heavily on manual labor, increased automation and innovation are necessary to meet evolving industry demands. Thus, the present study shows the advancements in the development of an autonomous compost turners through the introduction of an Industrial Internet of Things (IIoT) module. The module was methodically designed using the MBSE approach, and is intended to manage the acquisition, processing, web-server transmission, and display of compost data. The study demonstrates the successful deployment of the IIoT module within an industrial environment, showing that the adoption of MBSE contributes to improving communication, reducing risk, and increasing efficiency during the engineering development phase. Thus, the implementation of these technologies significantly improves waste management processes, reduces manual labor reliance, and enhances operational efficiency.

[Keywords: Automation, IIoT, Compost, Industry 4.0, Logistics]

Die vorliegende Arbeit untersucht die technischen und logistischen Potenziale zur Erreichung von Industrie 4.0-Standards in industriellen Kompostieranlagen mithilfe eines Model-Based Systems Engineering (MBSE) Ansatzes. Da herkömmliche Kompostierungsprozesse stark auf manuelle Arbeit angewiesen sind, müssen Automatisierung und Innovation vorangetrieben werden, um die steigenden Anforderungen der Industrie zu erfüllen. Die vorliegende Arbeit präsentiert daher die Fortschritte bei der Entwicklung eines autonomen Kompostwenders, indem ein IIoT-Modul (Industrial Internet of Things) vorgestellt

wird. Das Modul wurde methodisch unter Verwendung des MBSE-Ansatzes entworfen und dient der Erfassung, Verarbeitung, Übertragung zu Webserver und Anzeige von Daten aus dem Kompostierungsprozess. Die Arbeit zeigt den erfolgreichen Einsatz des IIoT-Moduls in einem industriellen Umfeld und belegt, dass die Anwendung von MBSE zur Verbesserung der Kommunikation, zur Risikominderung und zur Steigerung der Effizienz in der technischen Entwicklungsphase beiträgt. Die Einführung und Anwendung dieser Technologien ermöglicht somit eine deutliche Verbesserung der Prozesse der Kompostierung, verringert die Abhängigkeit von manueller Arbeit und erhöht die operative Effizienz.

[Schlüsselwörter: Automatisierung, IIoT, Kompost, Industrie 4.0, Logistik]

1 INTRODUCTION

Within the framework of the European Green Deal, the Circular Action Plan was adopted, which stipulates the mandatory separation of biological waste in the EU. [1], [2] The already rapid increase in recycling and composting amounts to 80% over the past 20 years and will be further fuelled under this new legislation. [3] Traditional processes in composting, such as measuring the gas and temperature of the compost windrows, are mainly based on manual labour and will therefore no longer be feasible in the future. To address these challenges, intensive research is currently being conducted at the Graz University of Technology in cooperation with its industrial partners. The focus of these international efforts is on the one side on aspects of the mechanical engineering domain, such as the development of a fully autonomous electric compost turner, see Figure 1. [4]–[7] On the other side there is a focus on conceptual solutions, such as improving sustainability and efficiency of these heavy-duty machinery through novel sharing systems. [8], [9] One subproject is the development of a

smart industrial internet of things (IIoT) - device which can autonomously acquire, transmit, process and store measured gas and temperature data of compost windrows. The key idea behind the concept of the Internet of Things (IoT) is to deploy smart objects which are capable of sensing the surrounding environment, transmit and process acquired data and feedback to the environment. One subset of the IoT is the Industrial Internet of Things (IIoT), which has its focus on the machine-to-machine and industrial communication technologies with automation applications. IIoT thus enables a better understanding of the manufacturing process, thereby improving efficiency and sustainable production. [10], [11] In the agricultural sector, which is closely related to composting, the motivation for the usage of IIoTs is to realize the intelligent identification, positioning, tracking, monitoring, and management of agricultural objects and processes. [12] Increasing automation in this area is also leading to more IIoT technologies being deployed. [13] This trend is additionally supported by large EU research projects (SENSEI [14] and IoT-A [15]). These two projects dealt with the use of IoT devices in agriculture, whereby both projects took a systematic approach. The present work also intends to follow a systematic approach, however the aim is now to pursue an approach in the sense of systems engineering (SE), specifically model-based systems engineering (MBSE). This decision is based on the increasing acceptance of MBSE in many other sectors, such as the automotive industry. [16], [17] The main concept of MBSE is to support system engineering activities such as system requirements definition and system architecture definition. This is achieved by moving from a document-based to a model-based engineering approach. Thus, the generated system models can act as an interdisciplinary communication platform to increase efficiency of a project workflow. A detailed discussion of MBSE concepts may be found in [18].

1.1 RESEARCH GAP AND THE RESOLVING RESEARCH QUESTION

As the previous chapter has shown, there are numerous research activities for the application of IIoT in agriculture, but much less work in the field of biological waste processing and composting. Concerning the domain of model-based systems engineering, research predominantly emphasizes the advancement of methodologies, while leaving the implementation and practical applications often behind. Therefore, in the first step, the present work will take advantage of the well-structured MBSE approach to develop a model of the IIoT device. In the second step, the technical feasibility of the MBSE model will be demonstrated by assembling a prototype of the IIoT device. The following research questions will be addressed:



Figure 1. Prototype of an autonomous electric-powered Compost Turner working on compost windrows at an industrial plant

- What are the methodological steps required for developing an MBSE model that encompasses the following process stages:
 - Detection of gas concentrations and temperature within a compost windrow, data processing and analysis, transmission to a web server, storage within a database, and data visualization?
 - Additionally, how are the system boundaries set?
- How can the final MBSE model be implemented on a technical basis and the IIoT device manufactured?

2 METHODS AND TOOLS

2.1 THE MODEL-BASED SYSTEMS ENGINEERING APPROACH

Due to the increasing complexity of systems, traditional approaches, which are mostly document-based, will no longer be sufficient. The fact that stakeholders from different disciplines are represented in this project justifies even more the need for an approach that both reduces complexity and has a well-structured workflow. Therefore, a method from the field of Systems Engineering was chosen, namely Model-Based Systems Engineering (MBSE), which is defined as:

The formalized application of modeling to support system requirements, design, analysis, verification and validation activities beginning in the conceptual design phase and continuing throughout development and later life cycle phases.[19]

In the concept phase of a Model-Based Systems Engineering (MBSE) project, a platform for problem synthesis, analysis, and stakeholder communication is crucial. This phase employs a combination of methods and models to define system architecture, with customer needs serving as the starting point. A model-based approach offers comprehensive information, and digital models facilitate continuous reuse and improved change traceability. Functional models, derived from customer needs, are linked at the system level for comparing various problem solutions. Behavioural simulation aids in tailoring system structures to required performances, necessitating logical and physical architecture models. The system model, which includes customer requirements analysis and functional, logical, and physical models, enables a multidisciplinary view, while specific models provide detailed perspectives.

Connecting different models using specific methods is a vital aspect of the model-based approach. Various system models support interdisciplinary information exchange, depending on the particular view. Since multiple modeling languages describe system models, establishing a consistent modeling structure and clarifying the appropriate method for model creation is essential, especially for the presented methodology's application. [8]

2.2 THE ARCADIA METHOD

Numerous methodologies within the realm of Model-Based Systems Engineering (MBSE) exist to address the

forementioned criteria. As each MBSE technique possesses distinct strengths and weaknesses, it is crucial to identify the most appropriate method for the specific task under consideration. In this particular instance, the desired methodology should facilitate a highly structured approach (comprehensive methodological guidance) and possess the capacity to manage the intricate complexities of a system, including features such as concealed complexity, filtering mechanisms, calculated connections, and accelerators. [20]

Since the ARCADIA method meets these requirements, the authors decided to employ this approach. ARCADIA is defined as follows:

ARCADIA is thus a structured engineering method for defining and verifying the architecture of complex systems. It promotes collaborative work among all key players, often in large numbers, from the engineering (or definition) phase of the system and subsystems, until their Independent Verification and Validation (IVV) [21]

In summary, ARCADIA is a systems engineering methodology based on the use of models. It focuses on the collaborative definition, evaluation and use of the model architecture. As a result, the method enables collaboration between all stakeholders involved.

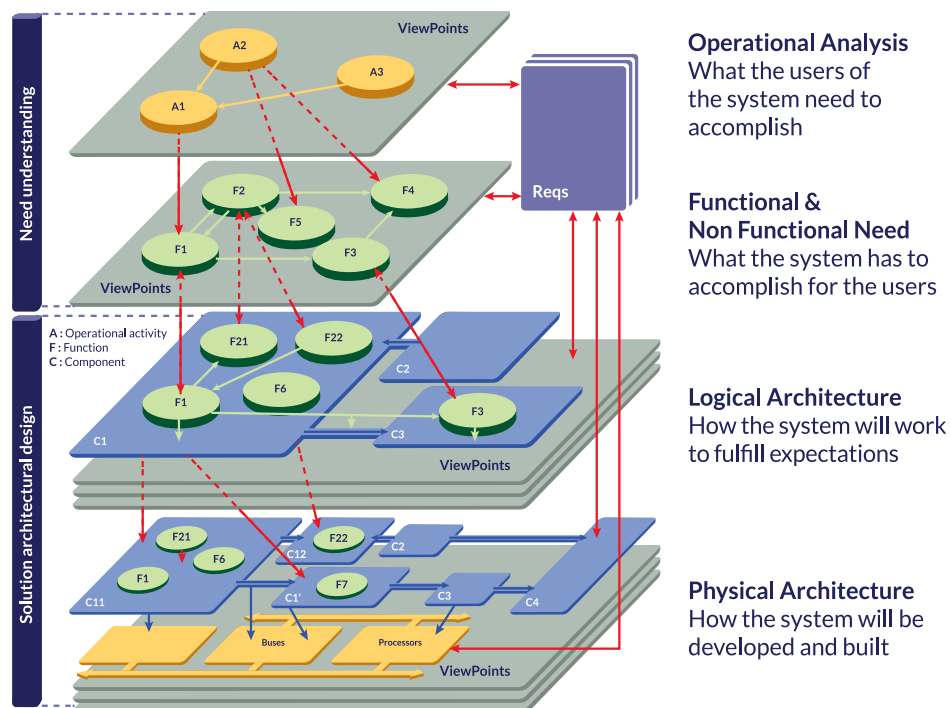

Figure 2. The ARCADIA Method

The ARCADIA method consists of four working levels, as depicted in Figure 2. Following a top-down approach, each successive level becomes increasingly subject-specific. The top level referred to as "Customer Operational Need Analysis," represents the most abstract layer. Its primary objective is to show what a user of the system wants to achieve, while the focus is on the stakeholders of the system.

The level below is called "System / Software / Hardware Needs Analysis". At this point, the task definition of the uppermost level gets reversed. Instead of asking what the user of the system has to fulfil, the objective is now to show what the system must do for the user. The focus of this level is on the system itself, considering the system only as a black box.

While the first two levels deal with the needs of the stakeholders and the system, levels three and four are dedicated to potential technical solutions. The third level is the "Logical Architecture Design". The system is now viewed as a white box. The objective is to show how the system works to meet the requirements from the "Operational Analysis" and the "System Needs Analysis." The focus is on examining the mutual interrelationships between the individual subsystems.

The fourth level, "Physical Architecture Design", continues one step further and represents the specific technical implementation of the "Logical Analysis". This level describes the physical components used in the actual implementation. At this point, the difference between the third level, the logical architecture, and the fourth level should be briefly clarified. In the logical architecture, the functions and dependencies of the individual subsystems are represented. However, it is not relevant which specific physical object will fulfill these functions. To give an example: in the third level, an "embedded computing board" subsystem might be modeled and its internal

functions described. In the fourth level, the same subsystem would be concretized, e.g. by deciding to use an "Nvidia Jetson Nano". However, such an in-depth modeling is often not necessary, and sometimes even misleading. Therefore, it is not uncommon to extend the MBSE model only to the third level, the Logical Architecture. [17], [20]

2.3 DEVELOPMENT OF THE IIOT DEVICE: METHODS AND TOOLS

After the previous chapter discussed how an MBSE model can be designed using the Arcadia method, all the methods and tools required for the technical implementation of the model will now be presented. Since there is no general definition for the terms IoT and IIoT, it should first be clarified how these terms are to be understood within the present study. The IoT, also referred to as "consumer Internet of Things", has its focus on individual users. In this context, the "Things" are smart electronic consumer devices that are interconnected with the objective of improving people's awareness of their environment while saving time and money. Consumer IoT communication can therefore be considered as machine-to-user and client-server interactions. [22], [23] The IIoT, on the other hand, may be considered as one of the fundamental pillars of digital manufacturing. The aim is to connect industrial plants, up to and including machines, control systems, information systems and business processes. The focus is primarily on the machine component, and aspects such as availability and reliability, as well as security and data protection, are given major importance. [11]

The machine-to-machine communication protocol "Open Platform Communication - Unified Architecture" (OPC-UA) was used in this work for the data communication between subsystems of the IIoT module,

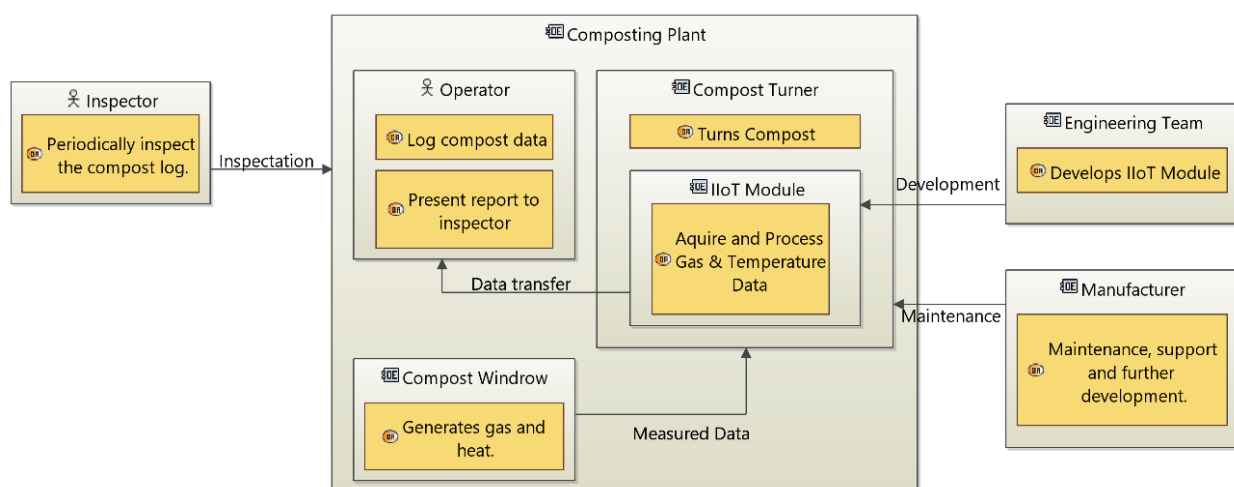

Figure 3. The Operational Analysis

and for the communication from IIoT to the web server. [24] The decision to use OPC-UA was based on its significant beneficial characteristics, such as platform independence, the possibility of encryption and authentication, and the support of comprehensive data modeling. A thorough examination of the OPC-UA protocol in contrast to other communication protocols can be found in reference. [25] The aforementioned network security of the IIoT module was achieved through the implementation of a virtual private network (VPN). Owing to its robust security measures, extensive configurability, and superior usability, the open-source software OpenVPN was employed. [26] For further comprehensive discussions and alternative VPN tools, kindly refer to reference [27]. The development of the individual subsystems within the IIoT device was performed using the software Codesys [28] and the Linux-based Robot Operating System (ROS) [29], as will be explained in detail in the Results section.

3 RESULTS

In the following chapter, the outcomes of the individual analysis steps of the MBSE method ARCADIA are presented. To ensure coherence, the analyses are presented in a top-down approach, adhering to the ARCADIA framework. This progression extends from the generalized Operational Analysis to the System Analysis, up to the technically specific Logical Analysis.

3.1 OPERATIONAL ANALYSIS

The guiding question of the Operational Analysis is "What does the user need to do with the system?". The focus is on the stakeholders of the system. The first step was therefore to identify the stakeholders involved in the IIoT device. As shown in Figure 3, the system consists of the stakeholders Composting Plant, Engineering Team, Manufacturer and Inspector. The stakeholders, their subsystems and their interdependencies are explained in detail below. One of the most important stakeholders is the Composting Plant, consisting of the Operator, Compost Turner and Compost Windrow. The operator's task is to regularly record the compost data, mainly the temperature of the compost windrows. The operator has to submit this report to the local authority, which carries out regular inspections. The Stakeholder Compost Turner is a highly complex technical system, which has a multitude of technical functions. For the present case, however, the function "Turns Compost" is of primary importance in this abstract operational analysis. Further, out of the numerous technical subsystems comprising the system compost turner, only the subsystem IIoT module is of importance at this level of consideration. The function of the IIoT module is to transmit the measured data from the compost windrows to the operator. Any other subsystems will be considered in deeper technical levels and mentioned in the corresponding following chapters. The Stakeholder Engineering Team is responsible for the development of the IIoT module. The Stakeholder Manufacturer is responsible for the technical manufacturing of the compost turner. Since the main focus in the present system is on the

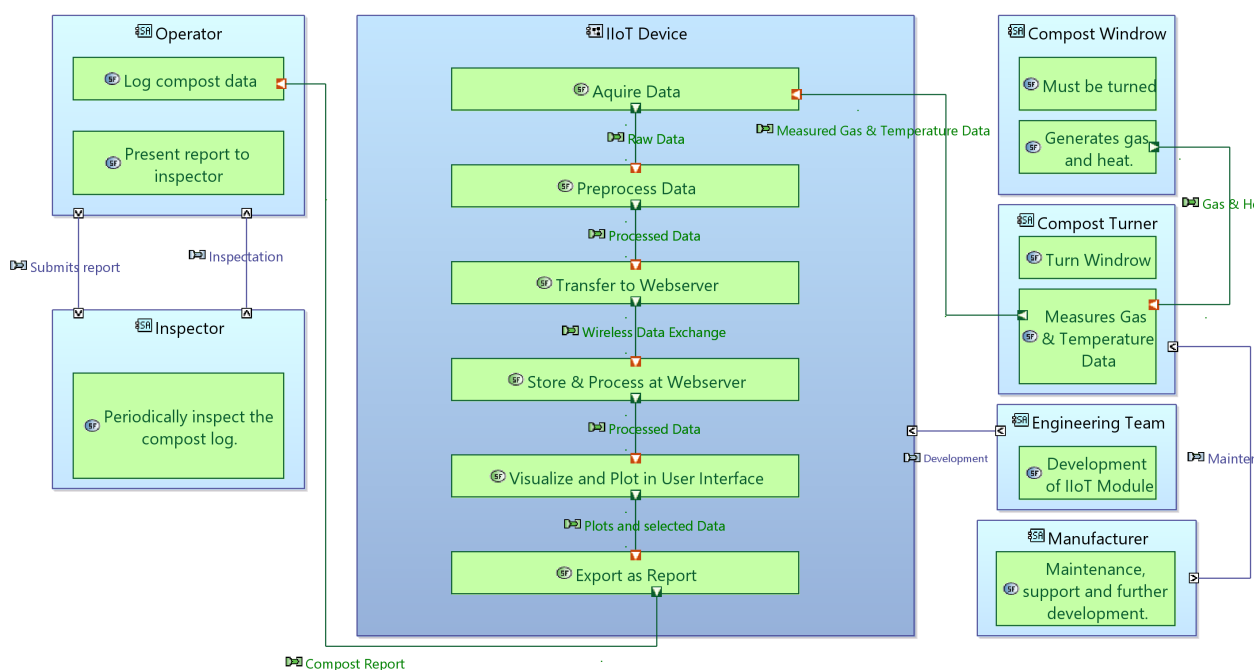

Figure 4. The System Analysis

IIoT Device, it is assumed that the compost turner has already been manufactured and is in operation. Thus, for the present system, the function of the Stakeholder Manufacturer consists of Maintenance, Support and further development of the compost turner. The function of the Stakeholder Inspector is to periodically inspect the log files of compost data.

At this point, it is important to specify the system boundaries in detail. The developed IIoT module has been specifically designed for the use in an industrial compost turner. Therefore, from a pragmatic point of view, the system boundaries of the IIoT module should be chosen as the actual physical perimeter barrier enclosing the composting facility. It is essential to highlight that the IIoT module possesses wireless communication functionality, which will be elaborated further in the subsequent technical analysis. As depicted in Figure 3, within the current system, the measured data information is retrieved by the stakeholder Operator, implicitly assuming that the data storage is situated at the composting plant. Obviously, the actual physical location of the data storage is not relevant, as long as the data can be retrieved. Therefore, in order to comply with the previously defined system boundaries, the present case shall assume that the data storage device is located at the composting plant.

3.2 SYSTEM ANALYSIS

The subsequent level is called the System / Software / Hardware Requirements Analysis. In this phase, the primary problem definition from the preceding level is inverted. Rather than asking what the user of the system has to fulfil, the aim is to demonstrate the system's essential purposes for the user. The focus at this stage is on the system itself, examining it solely as a black box.

Figure 4 illustrates the systems analysis for the present study. The diagram displays the components and the Systems: Inspector, Operator, IIoT Device, Compost Windrow, Compost Turner, Engineering Team, and Manufacturer (from left to right). Within each depicted system, the respective functions relevant to this level are shown. The IIoT Device represents the most crucial element in this context.

Starting from the system Compost Windrow, which has the property must be turned and generates gas and heat, the gas and temperature measurements are performed in the Compost Turner system. Subsequently, this data is transmitted to the IIoT module. Maintenance and support of the Compost Turner are performed by the stakeholder Manufacturer. This is important because ensuring the proper functioning of the compost turner is the basis for the proper functioning of the IIoT module.

After receiving the measurement data from the compost turner in the first step in the IIoT module, the data is then preprocessed. This is necessary, as on the one hand the raw measured data must be formatted and given a clear structure. On the other hand, at this point an averaging of the measured data has to be performed. As will be explained in more detail in the more technically specific analyses, averaging is necessary because the sensors provide a high-resolution data stream, while the final protocol that must be submitted to the authority requires data to be recorded over a period of months and thus a highly averaged data stream is required.

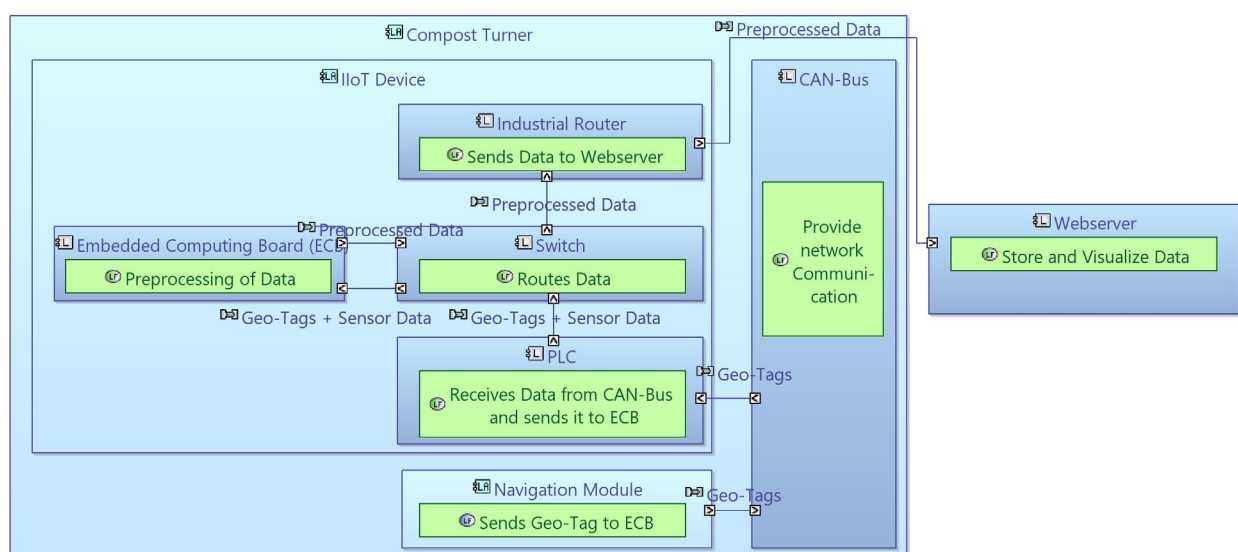

Figure 5. High-Level View of the Logical Architecture

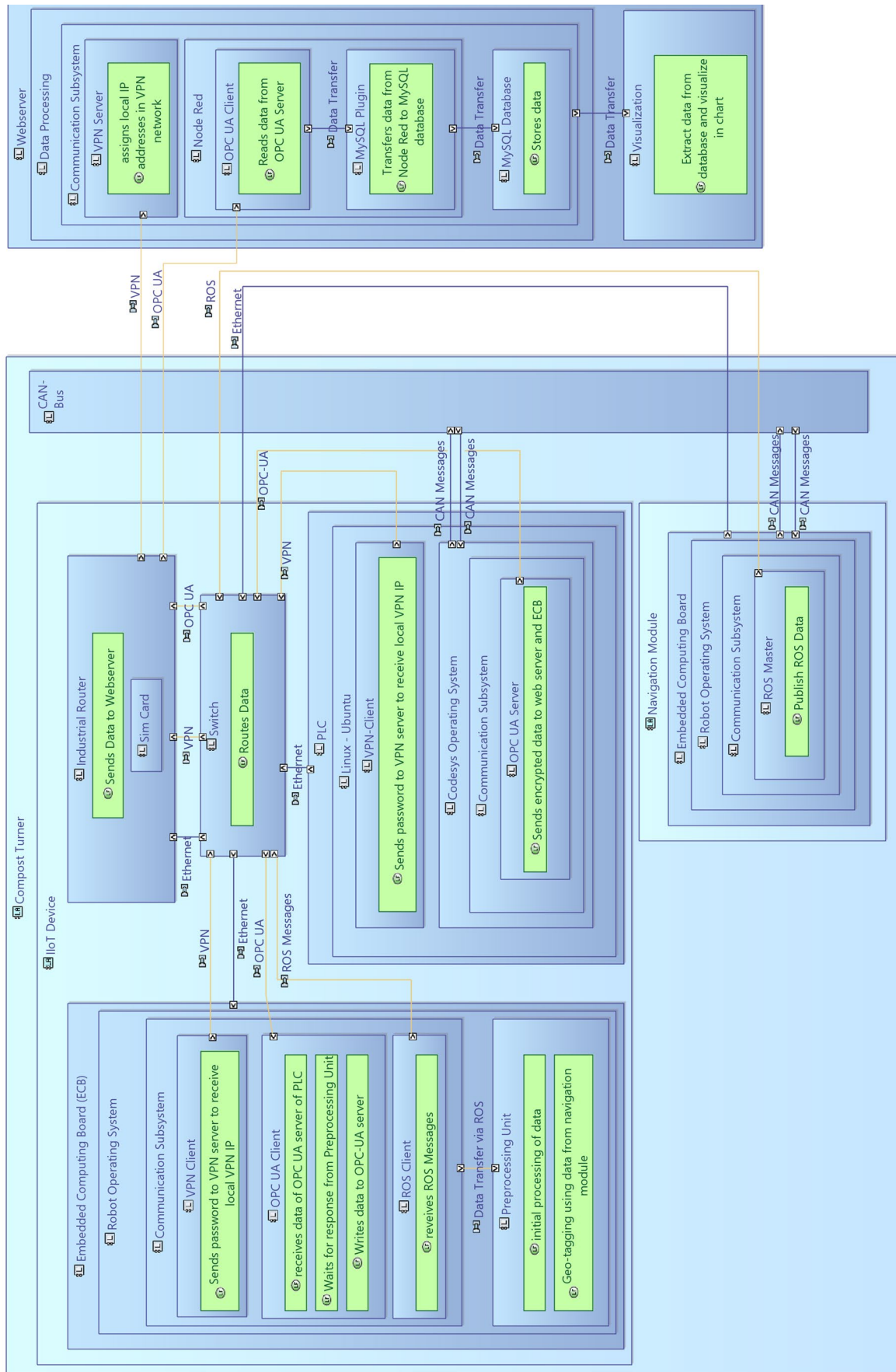

Figure 6. The Logical Architecture

The next step is to transfer the data to the web server. Once the data has been transferred to the web server, further processing of the data takes place and the data is stored. Subsequently, data visualization and plotting are executed within the user interface. In the final stage, "Export as Report," the accumulated and depicted data is generated in a structured format as a report intended for the relevant authority. This report can be exhibited to the operator during the "Present Report to Inspector" phase, which entails periodic inspections of the composting site.

As mentioned above, the focus of the System Analysis is on the question "What does the system has to do?", whereby the Logical Analysis explores the *implementation* of these defined functions. One may notice that there is a certain degree of overlapping between these two levels, thus raising the valid questions regarding the appropriate degree of technical specificity required at this level. This issue extend beyond the scope of the ARCADIA method and is a topic of considerable debate within the broader field of systems engineering. Therefore, it shall be kindly referred to the corresponding literature for a more profound scientific discourse on this subject. [17] For the present work, this topic was treated from a pragmatic point of view, with a focus on the industry partners. The depth of modeling in the first two levels, Operational Analysis and System Analysis, was set to a degree of technical detail that would allow all participating stakeholders - from the operator of the composting plant to the engineering team - to fully understand the entire system. It was only in the more concrete Logical Analysis that modeling of technical details was started, which were primarily of significance for the stakeholder Engineering Team.

3.3 LOGICAL ANALYSIS

Figure 5 shows a high-level view of the logical analysis. This layer is the most specific technical level. It primarily serves as a way for the members of the stakeholders Engineering Team to communicate and coordinate their tasks. Especially the interfaces and data connections between the IIoT Module and the other modules of the compost turner can be well visualized via the Logical Analysis. Therefore, this analysis can be seen as a great tool for communicating and discussing ideas. As mentioned in the introduction, the presented IIoT Module is a subsystem of the overall system "Autonomous Compost Turner", which is being developed by an international, multidisciplinary team. Therefore, it is even more important that the addressed interfaces are well-defined so that the IIoT module can be correctly integrated into the overall system Compost Turner.

As can be seen in Figure 5, the high-level logical analysis is therefore conducted starting from the system Compost Turner. Therefore, in addition to the IIoT module, the subsystem CAN bus and Navigation Module are also visualized. Within the bigger scope, the main task of the

Navigation Module is the object detection and route planning of the autonomous Compost Turner. However, even though route planning does not directly affect the IIoT module in the present context, the navigation module should nevertheless be included in the logical analysis, since it will serve another function, specifically the geo-tagging of the measured gas and temperature data.

The geo-tagged data generated by the Navigation Module is then transferred to the CAN bus. The task of the PLC is on the one hand to receive these geo-tags. On the other hand, the PLC must also receive the measured sensor data such as temperature and gas concentration of the compost windrows. The data is then bundled and transferred via the switch to the Embedded Computing Board (ECB). There the preprocessing of the data takes place by filtering and averaging the sensor data. The processed data is then sent via the switch to the router, which is responsible for the data transfer to the web server. At the web server, the functions defined in the previous step of the system analysis: "Store & Process", "Visualize and Plot" as well as "Export as Report" are technically implemented. The behaviour of the system just described corresponds to the high-level view from Figure 5. A much more specific view of the same system is shown in Figure 6. This view is essential for the communication between the technical teams. Accordingly, the main motivation was to describe the system on one side as comprehensively as possible, while on the other side maintaining a consistent and clear structure.

In the following, the individual subsystems of the detailed view are presented. In order to increase the readability, each system is written in italics when mentioned the first time. In the current detailed view, The IIoT Device consists of the subsystems *Embedded Computing Board* (ECB), *Programmable Logic Controller* (PLC), Industrial Router and Switch. The PLC operates on a Linux-based distribution, such as Ubuntu. This enables the implementation of a *Virtual Private Network* (VPN) client directly onto the PLC. Further discussion on the specific function of the VPN client will be provided in subsequent sections. Concurrently, a PLC operating system is executed on the Linux-based platform, which has the necessary functionality to establish a data connection with the web server. In this particular project, the Codesys operating system was employed on the PLC, and the data connection was established via an *OPC-UA server* in Codesys. The primary function of the OPC-UA server is the encrypted transmission of data. As illustrated by the blue connection lines in Figure 6, the PLC is linked to a switch via an Ethernet connection. The yellow connection lines indicate that a data connection is established within the VPN network utilizing the OPC-UA protocol.

The *Embedded Computing Board* (ECB) does also operate on an Ubuntu-based distribution, which hosts the Robot Operating System (ROS). It is worth noting that the

primary function of ROS is not solely for processing gas and temperature data, but is primarily used in the domain of control engineering for the autonomous compost turner. Therefore, only the two subsystems *Communication* and *Preprocessing Unit* are relevant for the current project. The former is used for bidirectional communication with the PLC, Navigation Module and web server. As can be seen in Figure 6, the *VPN Client* submodule is responsible for establishing a secure connection to the web server.

The primary role of the subsystem *OPC-UA Client* is to acquire the raw measured data from the PLC. To prevent synchronization errors, a predetermined time interval must be waited, allowing the preprocessing unit to adequately process the raw data. The last step is to send the data back to the OPC-UA server, which is then transferred to the web server. The subsystem *ROS Client* is responsible for receiving the geotags data sent from the Navigation Module. In the *Preprocessing Unit*, the initial procedure involves averaging of the acquired measurement data. Subsequently, this averaged data is assigned time stamps and geotags. This enables subsequent visualization on the web server, outlining the specific compost windrow where the data was measured and its corresponding time. Since both the communication subsystem and the preprocessing unit were implemented in ROS, the data communication takes place via corresponding ROS topics. For the system *Web Server*, the subsystems *Communication* and *Visualization* are of particular interest in the present case. The former consists of the subsystem *VPN Server*, which has the function of assigning IP addresses in the secured network. This is technically significant as the correct allocation of IP addresses is essential to ensure reliable communication between the Navigation Module, the PLC, the ECB and the web server. Node Red, a software commonly used for IIoT development, was used as the graphical development tool. Thereby, this system consists of two subsystems. The *OPC-UA client* is responsible for receiving the averaged, geotagged measurement data. The

only difference to the implementation in the ECB / ROS is that the data transmission is now performed wirelessly via the industrial LTE router. The *MySQL Plugin* submodule is responsible for transferring the measured data to a database, as represented by the *MySQL Database* submodule. In summary, the Data Processing and Communication system handles the workflow of receiving data, transmission, storage in the database, and subsequent visualization via the web interface.

3.4 DEVELOPMENT AND MANUFACTURING OF THE IIOT MODULE

The IIoT module was manufactured in accordance with the specified logical architecture. The final IIoT module is shown in Figure 7. According to the logical architecture, the main components consist of the PLC, the router and the switch. Due to the worldwide supply limitations, the required ECB could not be acquired at the time of writing. Therefore, the decision was made to substitute the ECB with a laptop operating the Robot Operating System. Even though its integration into the IIoT module is restricted by a lack of sufficient space, this setup has similar characteristics as the ECB and is therefore applicable. The IIoT module has a LAN connector (RJ45) located on its exterior to ensure connectivity with the subsystems ROS and Navigation Module. The enclosure of the IIoT module is fabricated from durable polycarbonate material and adheres to the IP67 certification standards. A Revolution PI was selected as the PLC, as it meets the required specifications for the intended application. Due to the externally mounted LTE connectors, an antenna can be attached directly, as shown in the illustration. In case the IIoT module has to be installed in a closed control rack, it is also possible to mount the LTE antennas on the outside to ensure the best possible wireless signal strength.

Owing to its technical design, the manufactured IIoT module has a robust and reliable performance, consistently

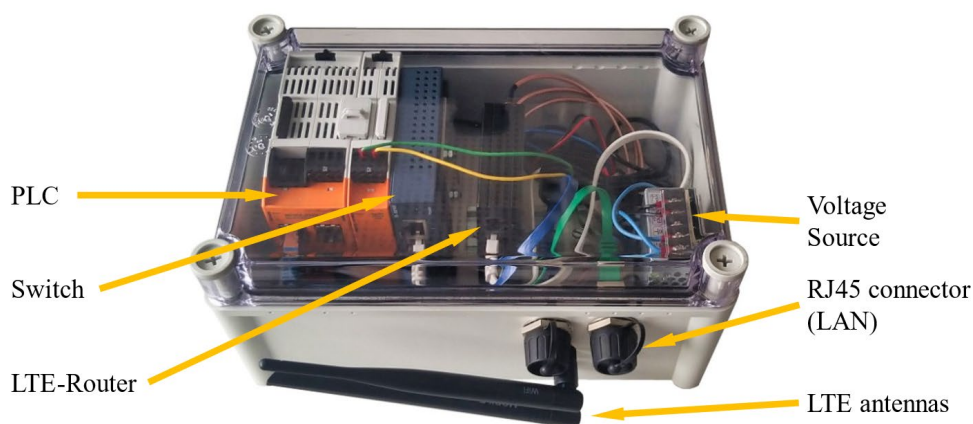

Figure 7. The final IIoT Device

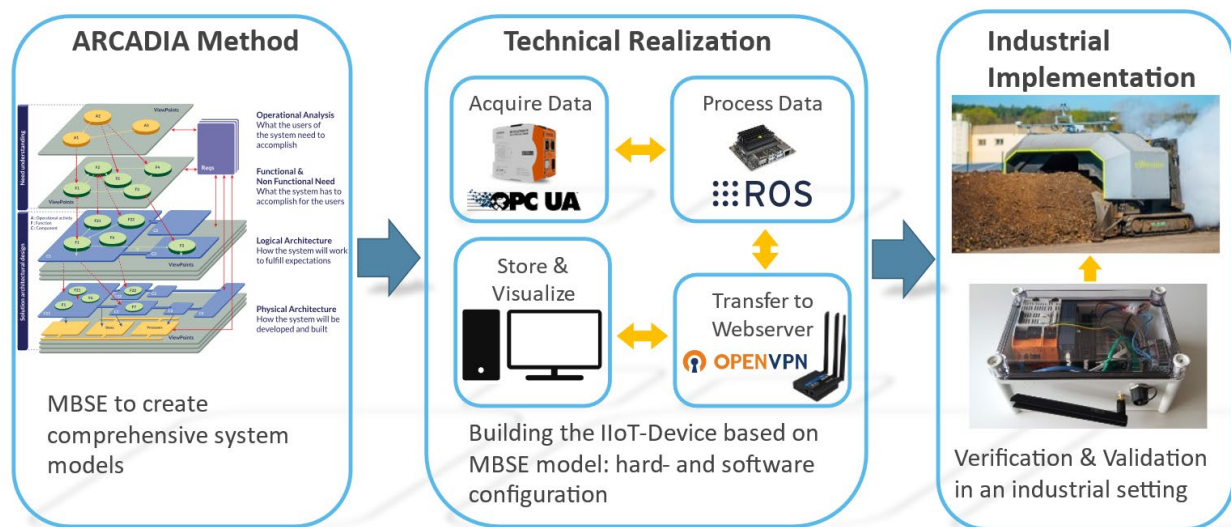

Figure 8. Applying MBSE to develop an IIoT-Device for data acquisition, processing, storing and web-based visualization.

providing the required functionalities under the demanding conditions in an industrial composting plant.

4 DISCUSSION

The present work demonstrates the successful application of the MBSE method ARCADIA in the development of an IIoT module within an international multidisciplinary team. The IIoT module is designed to perform data processing, transmission, storage, and final visualization for an industrial composting system. Following the methodical development of the module, the technically specific logical analysis was carried out and the IIoT module was manufactured according to the designed architecture. For this objective, commercially available components were used for the hardware setup. The required software components were defined by the logical analysis and subsequently implemented on the corresponding hardware infrastructure. This demonstrated the feasibility of applying the MBSE methodology ARCADIA in the development of an IIoT module from conception to technical production up to the final programming implementation.

The presented IIoT module was developed within the context of the higher-level project "autonomous compost turner", thereby possessing a distinct and well-defined scope of application. Nevertheless, when examining the methodology used in this work, one might claim that this approach possesses the potential for generalization within the domain of heavy-duty agricultural machinery. Obviously, the ARCADIA method is designed for a wide range of applications. For the present work, it can be claimed that both, the methodological approach and the specific MBSE models are applicable to the field of agriculture. Let us consider a hypothetical scenario where

one wants to develop an IIoT module for an arbitrary heavy-duty agricultural machine. In the operational analysis, irrespective of the specific application, stakeholders such as operators, engineering teams, manufacturers, and potentially inspectors will likely be involved. In addition, depending on the use case, further stakeholders will be involved and corresponding interactions between the stakeholders will occur. The systems analysis will also look different depending on the use case, but a certain structure will be found in any case. Thus, the functions Acquire Data, Transfer to Web server, Store & Process and Visualize and Plot will most likely be found in the systems analysis in any given use case. However, the interactions of the system with the stakeholders will of course vary from case to case. Concerning the Logical Analysis, a generalization towards an arbitrary use case in the agricultural field may prove to be challenging. Depending on the specific application, a wide variety of systems and subsystems will emerge. Nevertheless, there are some fundamental capabilities which should be discussed. Thus, there will be a need for a secure data connection to the web server in any case. Since it can be assumed that a high level of data security is required, the use of a VPN connection is very likely. Although there are several protocols for the data connection, the OPC-UA protocol is widely accepted within the industry, therefore it is expected that this protocol will be used. Regarding the subsystems ECB and Router described in the present work, one can only assume how these two elements would appear in a generalized scenario. They could either appear as separate components, as in this work, or they could be integrated into an already existing ECB, which would only require an adaptation of the software component. The latter is especially likely if the heavy-duty agricultural machine already possesses a certain degree of automation, which necessarily requires

corresponding hardware components. A graphical representation of the aforementioned approach to the systematic design and prototypic manufacturing of an IIoT device within the agricultural sector is given in Figure 8.

Despite the obvious capabilities of the IIoT module, it is important to address some self-reflective criticisms. In particular, the subject of modeling depth requires further discussion. It is apparent that there is no singular, uniform methodology, and therefore the modeling depth must be determined on a case-by-case basis for each application of MBSE. The approach chosen in this study, which was to determine the level of detail in such a way that the industrial partners are provided with the optimal comprehensive understanding of the entire system, may well be viewed critically. However, it should be mentioned that a fundamental principle of the ARCADIA method involves the intentional exclusion of subsystem visualization if it fails to contribute additional value to the observer. Within this approach, the concept of a "filtered view" is employed, which aims to provide a clearer view of the overall system.

In conclusion, the development of an IIoT device for the composting industry provides numerous opportunities to improve the efficiency and sustainability of the composting process. The operational, system, and logical analysis provided a comprehensive understanding across stakeholders, the systems and subsystems of the IIoT device, and their mutual interdependencies. The challenges faced during the development process highlight the need for effective communication and collaboration between members of the multidisciplinary team and the importance of defining clear system boundaries.

Future improvements to the IIoT device could focus on improving communication protocols, data processing techniques, and a more compact design of the IIoT device. By addressing these challenges and continuously improving the system, the IIoT device has the potential to improve the composting process and contribute to the development of more sustainable biological waste management practices.

AUTHOR CONTRIBUTIONS

Conceptualization, M.C. and C.L.; methodology, M.C. and C.L.; software, M.C.; validation, M.C. and C.L.; formal analysis, M.C. and C.L.; investigation, M.C.; resources, M.C.; data curation, M.C.; writing—original draft preparation, M.C.; writing—review and editing, M.C. and C.L.; visualization, M.C.; supervision, C.L.; project administration, M.C.; funding acquisition, M.C. and C.L. All authors have read and agreed to the published version of the manuscript.

FUNDING

This research was funded by the Austrian Federal Ministry of Finance via the Austrian Research Promotion Agency in the research project ANDREA (Grant No. 885368).

LITERATURE

- [1] European Commission, "EU climate action and the European Green Deal," *Klimapolitik - European Commission*, 2023. https://ec.europa.eu/clima/policies/eu-climate-action_en (accessed Apr. 21, 2023).
- [2] European Commission, *Circular Economy Action Plan - For a cleaner and more competitive Europe*. Luxembourg: Publications Office of the European Union, 2020. Accessed: Apr. 21, 2023. [Online]. Available: <https://op.europa.eu/en/publication-detail/-/publication/45cc30f6-cd57-11ea-adf7-01aa75ed71a1>
- [3] European Statistical Office, "Municipal waste by waste management operations." European Commission, Apr. 14, 2023. Accessed: Apr. 21, 2023. [Online]. Available: <https://ec.europa.eu/eurostat/databrowser/bookmark/b417d0a6-bfff-49a5-886d-60ff76a0d352?lang=en>
- [4] M. Cichocki, E. Reitbauer, F. Theurl, and C. Schmied, "Composting 4.0: From The Automatic Steering Of Compost Turners Towards An Autonomous Plant Management," presented at the Conference: 7th Central European Biomass Conference (CEBC), Graz, Austria, Jan. 2023. doi: 10.13140/RG.2.2.25449.16483.
- [5] M. Cichocki, E. Reitbauer, C. Schmied, and F. Theurl, "From Waste to Resource: Leveraging Simulation-based Technologies in the Development of an Autonomous Compost Turner," presented at the Logistikwerkstatt Graz, Graz, Austria, May 2023. doi: 10.13140/RG.2.2.23736.52486/1.
- [6] E. Reitbauer, "Multi-Sensor Positioning for the Automatic Steering of Tracked Agricultural Vehicles," 2022. doi: 10.3217/978-3-85125-919-3.
- [7] M. Schedler, A. Ortner-Pichler, E. Reitbauer, G. Mahringer, and C. Landschützer, "Interdisciplinary System Simulation of a Tracked Compost Turner," *Procedia Manufacturing*, vol. 51, pp. 1005–1013, 2020, doi: 10.1016/j.promfg.2020.10.141.
- [8] M. Cichocki, C. Landschützer, and H. Hick, "Development of a Sharing Concept for Industrial Compost Turners Using Model-Based Systems Engineering, under Consideration of Technical and Logistical Aspects," *Sustainability*, vol. 14, no. 17, p. 10694, Aug. 2022, doi: 10.3390/su141710694.

- [9] M. Cichocki, C. Landschützer, A. V. Barenji, and B. Montreuil, "Physical Internet based Hyperconnected Logistics Platform Enabling Heavy-Duty Machinery Sharing in the Composting Industry: A Simulation-Based Scenario Investigation," presented at the 9th International Physical Internet Conference (IPIC), Athens, Greece, Jun. 2023.
- [10] O. Vermesan *et al.*, "Internet of Things Strategic Research Roadmap," Jan. 2009.
- [11] E. Sisinni, A. Saifullah, S. Han, U. Jennehag, and M. Gidlund, "Industrial Internet of Things: Challenges, Opportunities, and Directions," *IEEE Trans. Ind. Inf.*, vol. 14, no. 11, pp. 4724–4734, Nov. 2018, doi: 10.1109/TII.2018.2852491.
- [12] J. Xu, B. Gu, and G. Tian, "Review of agricultural IoT technology," *Artificial Intelligence in Agriculture*, vol. 6, pp. 10–22, Jan. 2022, doi: 10.1016/j.aiaa.2022.01.001.
- [13] V. Bellon Maurel and C. Huyghe, "Putting agricultural equipment and digital technologies at the cutting edge of agroecology," *OCL*, vol. 24, no. 3, p. D307, May 2017, doi: 10.1051/ocl/2017028.
- [14] M. Presser, P. Barnaghi, M. Eurich, and C. Villalonga, "The SENSEI project: Integrating the physical world with the digital world of the network of the future," *Communications Magazine, IEEE*, vol. 47, pp. 1–4, May 2009, doi: 10.1109/MCOM.2009.4907403.
- [15] M. Bauer *et al.*, *Internet of Things – Architecture IoT-A Deliverable D1.5 – Final architectural reference model for the IoT v3.0*. 2013.
- [16] H. Hick, M. Bajzek, and C. Faustmann, "Definition of a system model for model-based development," *SN Appl. Sci.*, vol. 1, no. 9, p. 1074, Aug. 2019, doi: 10.1007/s42452-019-1069-0.
- [17] H. Hick, K. Küpper, and H. Sorger, *Systems Engineering for Automotive Powertrain Development*, 1st edition. Cham: Springer International Publishing, 2021. [Online]. Available: <https://ebookcentral-1proquest-1com-1a2xt82zl01a6.ftubhan.tugraz.at/lib/graz/detail.action?docID=6498191>
- [18] M. Bajzek, J. Fritz, H. Hick, M. Maletz, C. Faustmann, and G. Stieglbauer, "Model Based Systems Engineering Concepts," in *Systems Engineering for Automotive Powertrain Development*, H. Hick, K. Küpper, and H. Sorger, Eds., in Powertrain. Cham: Springer International Publishing, 2020, pp. 1–40. doi: 10.1007/978-3-319-68847-3_8-1.
- [19] INCOSE, *Systems Engineering Vision 2020*. International Council on Systems Engineering (INCOSE), 2007.
- [20] P. Roques, *Systems Architecture Modeling with the Arcadia Method: A Practical Guide to Capella*. London: Elsevier, 2017.
- [21] S. Bonnet, J.-L. Voirin, D. Exertier, and V. Normand, "Modeling system modes, states, configurations with Arcadia and Capella: method and tool perspectives," *INCOSE International Symposium*, vol. 27, no. 1, pp. 548–562, 2017, doi: <https://doi.org/10.1002/j.2334-5837.2017.00378.x>.
- [22] M. Palattella *et al.*, "Internet of Things in the 5G Era: Enablers, Architecture and Business Models," *IEEE Journal on Selected Areas in Communications*, vol. 34, pp. 1–1, Mar. 2016, doi: 10.1109/JSAC.2016.2525418.
- [23] D. Bandyopadhyay and J. Sen, "Internet of Things: Applications and Challenges in Technology and Standardization," *Wireless Personal Communications*, vol. 58, pp. 49–69, May 2011, doi: 10.1007/s11277-011-0288-5.
- [24] C. Almeida, "Unified Architecture," *OPC Foundation*. <https://opcfoundation.org/about/opc-technologies/opc-ua/> (accessed Jul. 26, 2022).
- [25] R. Langmann, "Vernetzte Systeme für die Automatisierung 4.0: Bussysteme – Industrial Ethernet – Mobile Kommunikation – Cyber-Physical Systems," p. 389.
- [26] OpenVPN Inc., "OpenVPN," 2022. <https://openvpn.net/> (accessed Jul. 27, 2022).
- [27] A. Alshalan, S. Pisharody, and D. Huang, "A Survey of Mobile VPN Technologies," *IEEE Communications Surveys & Tutorials*, vol. 18, no. 2, pp. 1177–1196, 2016, doi: 10.1109/COMST.2015.2496624.
- [28] CODESYS GmbH, "CODESYS," 2022. <https://www.codesys.com/> (accessed Jul. 27, 2022).
- [29] Open Source Robotics Foundation, Inc., "ROS - Robot Operating System," 2022. <https://www.ros.org/> (accessed Jul. 27, 2022).

Dipl.-Ing. Max Cichocki, M.Sc., University Assistant at the Institute of Logistics Engineering, Graz University of Technology.

Assoc.Prof. DI Dr.techn. Prof.h.c. Christian Landschützer Professor at the Institute of Logistics Engineering, Graz University of Technology.

Address: Institute of Logistics Engineering, Graz University of Technology, Inffeldgasse 25/E, 8010 Graz, Austria, www.itl.tugraz.at